

GRAF

H = **750** mm

Top = **18** mm

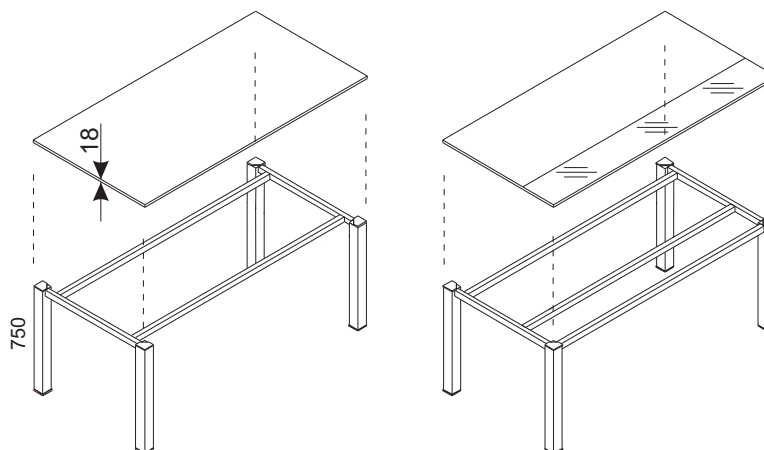

MATERIALS AND FEATURES

- High quality E1 chipboard, coated with melamine resin on both sides;
- 2 mm plastic edge with a radius of 3 mm;
- Top 18 mm thick as a STANDARD;
- Self-supporting frame comprising of various welded steel side parts that are screwed together with two steel beams;
- Chromed decorative inserts;
- 12 mm satinato or antisol graphite glass as a top in conference and occasional tables; 8 mm as an insert in conference tables;
- Colors according to MARO range.

HEIGHT ADJUSTMENT

750 mm height with +15 mm leveling feet.

CABLE MANAGEMENT

Horizontal:

- fold-down cable channel (can be attached later) made of powder-coated steel, installed under table top;
- fixed cable channel (can be attached later) made of powder-coated steel, installed under table top;
- cable clamps (plastic) installed under table top.

Vertical:

- flexible, plastic cable channel;
- two-element cable channel
- cable outlets and netboxes;
- standalone cable leg.



RECOMMENDED PRODUCTS

- Cabinets and sideboards with Z1 handles;
- Metal GraF feet (46 mm or 70 mm) with leveling system +10 mm;
- Sideboards (720 mm): mobile, with hinged doors, with drawers;
- For add-on GraF sideboard, one should select a desired unit, change the top from 25 mm to 18 mm and add GraF 46 mm feet - total height of 750 mm.
- PC holders, PC trolleys, etc., please see page I. 25 'eM ACCESSORIES';
- TOP pedestals and TOP high pedestals.





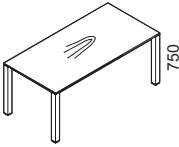
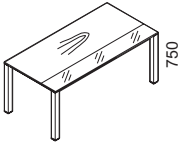

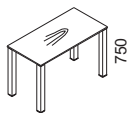
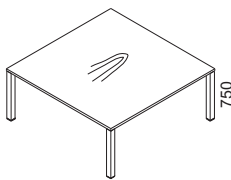
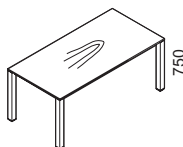
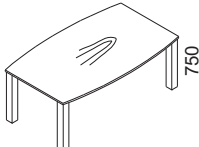

		COLORS	TOPS		MODESTY PANELS PARTITION SCREENS 18 mm	UNDER- FRAME	METAL MODESTY PANELS
			18 mm	25 mm			
MELAMINE	GROUP 1	White U1	●	—	●	—	—
		Light Grey U2	●	—	●	—	—
		Light Maple D7	●	—	●	—	—
		Oak Napolitano D3	●	—	●	—	—
		Beech D2	●	—	●	—	—
		Cherry Havana D1	●	—	●	—	—
		Walnut Maroni D10	●	—	●	—	—
	Graphire U4	●	—	●	—	—	
	GROUP 2	Gloss White U9(HG)	—	—	●	—	—
		Gloss Orange U8(HG)	—	—	●	—	—
Gloss Green U7(HG)		—	—	●	—	—	
Gloss Red U6(HG)		—	—	●	—	—	
FRAME	White M02	—	—	—	●	●	
	Aluminium M01	—	—	—	●	●	
	Graphite M05	—	—	—	●	●	

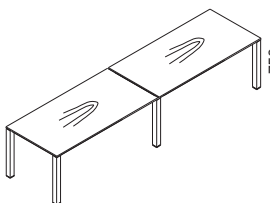
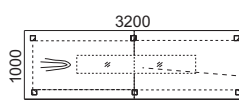
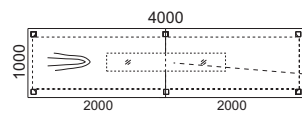
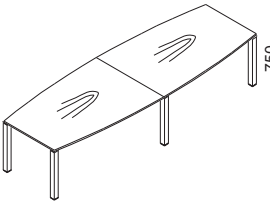
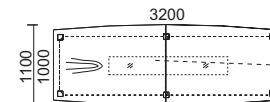
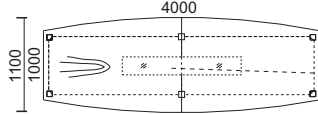
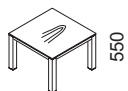
Full collection of chipboards available at: www.PFLEIDERER.com
Other metal colors available according to RAL palette.

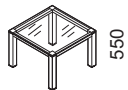

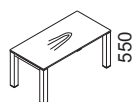
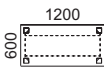
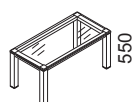
GRAF

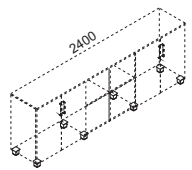
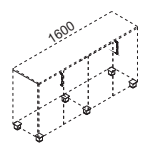
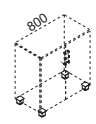

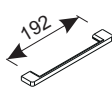
1. GraF desk	Code	Net price
	1600x800 GB 01 1800x800 GB 02 2000x800 GB 03 1800x900 GB 05 1800x1000 GB 07 2000x1000 GB 06	
2. GraF desk with glass insert 	1600x800 GB 21 1800x900 GB 24 2000x1000 GB 26	
3. Add-on GraF table 	1200x600 GU 01 1600x600 GU 02	
4. Add-on GraF table 	1200x600 GU 03 1600x600 GU 04	
5. GraF square conference table 	Chipboard 18mm GT 01 Chipboard 18mm GT 02 Chipboard 18mm GT 03 Glass 450x450x8 GT 04	
6. GraF rectangular conference table 	Chipboard 18mm GT 05 Glass 800x250x8 GT 06 Chipboard 18mm GT 07 Glass 800x250x8 GT 08	
7. GraF shaped conference table 	Chipboard 18mm GT 09 Glass 800x250x8 GT 10 Chipboard 18mm GT 11 Glass 800x250x8 GT 12	

GRAF

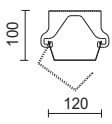
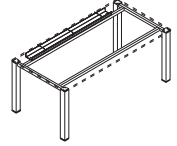
8. GraF multi-element rectangular conference table		Code	Net price			
		Chipboard 18mm	GT 13			
		Glass 1200x250x8	GT 14			
		Chipboard 18mm	GT 15			
		Glass 1200x250x8	GT 16			
9. GraF multi-element shaped conference table						
		Chipboard 18mm	GT 17			
		Glass 1200x250x8	GT 18			
		Chipboard 18mm	GT 19			
		Glass 1200x250x8	GT 20			
10. GraF square occasional table						
		Chipboard 18mm	GT 31			
		Glass 12 mm	GT 32			
11. GraF rectangular conference table						
		Chipboard 18mm	GT 33			
		Glass 12 mm	GT 34			
12. GraF metal foot with leveling system (OPTION)						
				Single - 70 mm	WS 93	/ pc
<p>For 2400mm credenza unit - 8pcs WS 93</p>	<p>For 1600mm credenza unit - 6pcs WS 93</p>	<p>For 800mm credenza unit - 4pcs WS 93</p>		Single - 46 mm	SW 93	/ pc
13. Z1 handle - recommended for PRO credenza units and cabinets						
	Surcharge for replacement (Z1 handles instead of standard turn knob)		/ pc			

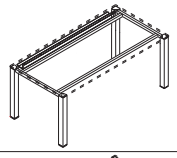
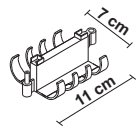
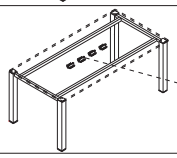
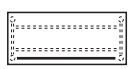
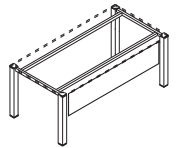
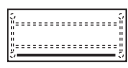
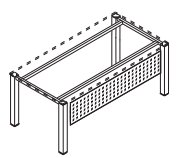
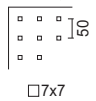
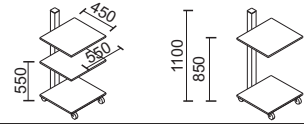
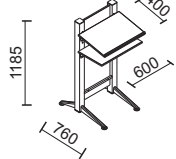
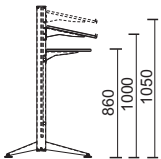
GRAF

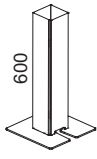
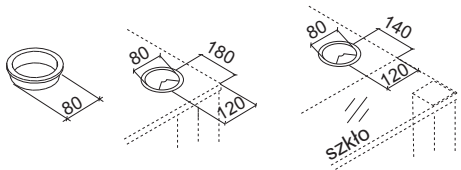
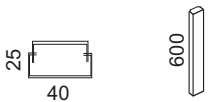
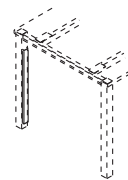
14. Fold-down cable channel  						
				800 mm (for 1200 desk) 1200 mm (for 1600 desk) 1400 mm (for 1800 desk) 1600 mm (for 2000 desk)	DD 06 DD 04 DD 03 DD 02	
15. Fixed cable channel  				800 mm (for 1200 desk) 1200 mm (for 1600 desk) 1400 mm (for 1800 desk) 1600 mm (for 2000 desk)	DD 23 DD 25 DD 26 DD 27	
16. Cable clamp 						DD 91 /pc
17. Chipboard modesty panel  				1000 x 360 mm (for 1200 desk) 1400 x 360 mm (for 1600 desk) 1600 x 360 mm (for 1800 desk) 1800 x 360 mm (for 2000 desk)	ZR 03 ZR 05 ZR 06 ZR 07	
18. Latticed modesty panel  		Holes type 		1000 x 360 mm (for 1200 desk) 1400 x 360 mm (for 1600 desk) 1600 x 360 mm (for 1800 desk) 1800 x 360 mm (for 2000 desk)	ZR 13 ZR 15 ZR 16 ZR 17	
19. Mobile computer table 				3 shelves 2 shelves	GD 10 GD 11	
20. Lectern with top shelf height adjustment H1=1000 H2=1050		 		Chipboard front	GD 12	

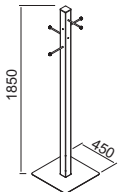
Product	Code	Net price	Product	Code	Net price
21. Vertical GraF cable channel h=600 mm 			24. Chromed cable outlet 	GD 15	WD 01
22. Vertical cable channel, two-element, metal, mounted to leg (bolted or stuck on)  			25. Rotating netbox for conference tables and executive desks Available modules: Coax, Telephone, Data, Multimedia Price according to specification	UW 18	GD 18 /1 set * Fixed price 230V, RJ 45 sockets
23. Vertical elastic cable channel 			26. GraF coat hanger 	UW 02	GD 17

GRAF CREDENZA UNITS

2 OH, 3 OH, 5 OH units include: 18 mm top, GraF feet, doors with satinato or antisol graphite glass in aluminum frame, Z1 handles.

CREDENZA UNITS - MODEL 01

CREDENZA UNITS - MODEL 02

Model 01 additionally includes side and top facings and, in 2 OH and 3 OH units, glass top mounted on plinths (H=60 mm, fi=32 mm) chromed or powder coated.

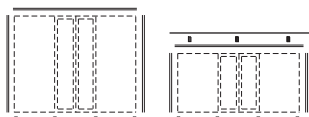

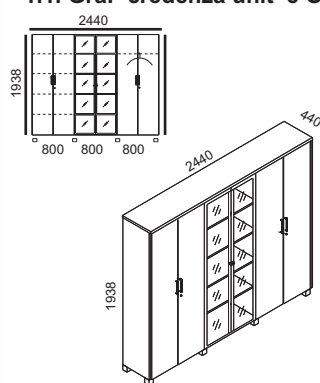
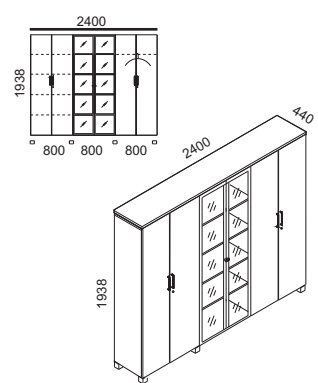
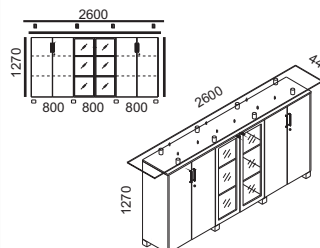
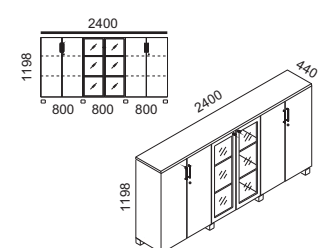
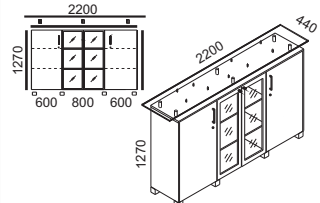
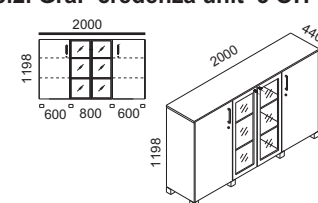
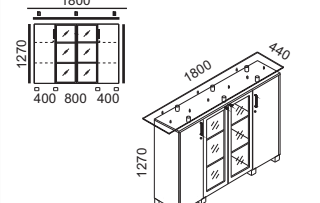
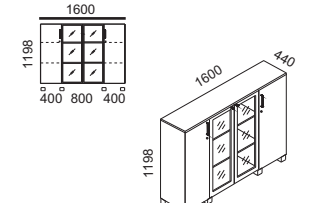
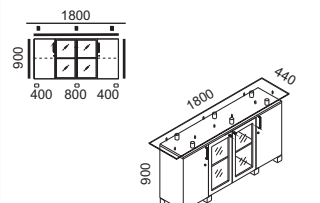
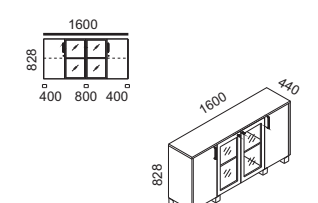
	Code/ Net price		Code/ Net price	Description
1.1. GraF credenza unit 5 OH 	GS 32	1.2. GraF credenza unit 5 OH 	GE 82	GS 32; GE 82 Filing-shelf-filing GS 32, GS 82; glass in alu frame
	GS 33		GE 83	Gs33; GE 83 GS 33; GS 83; glass in alu frame
	GS 40		GE 84	GS 40; GE 84 Filing-shelf-filing Open middle segment
	GS 42		GE 85	GS 42; GE 85 Filing-shelf-wardrobe Open middle segment
2.1. GraF credenza unit 3 OH 	GE 48	2.2. GraF credenza unit 3 OH 	GE 91	GE 48; GE 91 Filing-shelf-filing GE 48; GE 91; glass in alu frame
	GE 49		GE 92	GE 49; GE 92 Filing-shelf-filing Open middle segment
3.1. GraF credenza unit 3 OH 	GS 37	3.2. GraF credenza unit 3 OH 	GS 57	GS 37; GS 57 Filing-shelf-filing GS 37; GS 57; glass in alu frame
4.1. GraF credenza unit 3 OH 	GE 50	4.2. GraF credenza unit 3 OH 	GE 93	GE 50; GE 93 Filing-shelf-filing GE 50; GE 93; glass in alu frame
	GE 51		GE 94	GE 51; GE 94 Filing-shelf-filing Open middle segment
5.1. GraF credenza unit 2 OH 	GE 54	5.2. GraF credenza unit 2 OH 	GE 98	GE 54; GE 98 Filing-shelf-filing GE 54; GE 98; glass in alu frame
	GE 55		GE 99	GE 55; GE 99 Filing-shelf-filing Open middle segment

NOTES