

# New School technical specification



**.mdd has a leading position among manufacturers of office furniture with many awards that prove quality and continuously increase demand for its products.**

The realities of today's market require constant quality improvement at all levels of modern organization. This applies in particular to customer service, marketing, quality of products and also to quality of processes within the company. Partnership relations among employees and with business partners form a base of economic growth and success of the company.

Constant investments in innovative machinery park, optimization of management systems and an expansion of production halls allow to minimize the lead times for the product of the highest quality.

**More than twenty years of experience in office furniture industry come with reference from a long list of companies and institutions to show their appreciation for an efficient and comprehensive service. .mdd is highly aware of the environment.**

Being located in the forest region with lake by its side, .mdd takes the nature seriously and invests constantly in a modern and energy-efficient solutions to preserve the local life. Company puts emphasis on waste segregation and recycling. .mdd has been awarded for the exceptional care and involvement in waste disposal. All materials used are environmentally friendly and enjoy a high 95 % rate of being recycled.



**General informations:**

**Warranty:**

.mdd products - **5 years**.  
Electrical components and fabric - **2 years**.

**Certificate - MFC:**



**Certificate - fabric:**



**Prizes and awards:**



**Assembly:**

the product comes pre-assembled

**Packing:**

cardboard

New School	Date of preparation 09.11.2020	The data contained in this document is valid in the day of its preparation. Change of the product, as long as it does not affect the basic features of it, does not require consistent updates of the document.	page 2/8 <b>general informations</b>
------------	-----------------------------------	---	---

## Technical specification

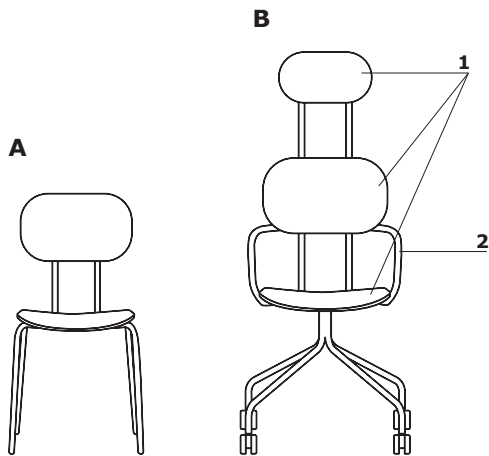

1. **Seat, backrest, headrest** - upholstery (NEW1T, NEW2T), plywood (NEW1W, NEW2W)
2. **Armrests** - metal (right + left) in frame colour; OPTION WITH EXTRA CHARGE - for seat, backrest NEW1T, NEW1W

A - NEW1T, NEW1W, B - NEW2T, NEW2W; max. load 120 kg

## New School

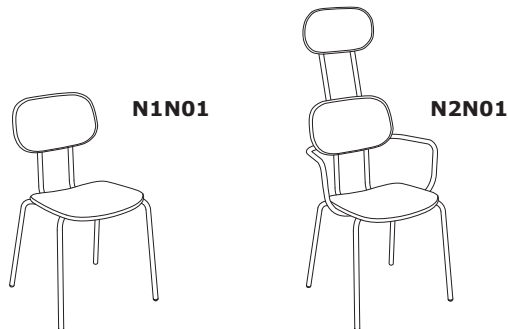

### Base N1N01/N2N01:

- 4 - legged metal frame made of tube Ø18 mm,
- wall thickness 2 mm, powder coated



### Base N1N07/N2N07:

- 4 - star metal frame
- frame made of tube Ø18 mm, wall thickness 2 mm, powder coated
- swivel seat - 360°



### Base N1N03K/N2N03K:

- 4 - star metal frame
- castors for soft floors
- frame made of tube Ø18 mm, wall thickness 2 mm, powder coated
- fixed seat

---

## New School



**N1N04H**

**Base N1N04H:**

- low stool
- cantilever, metal
- frame made of tube Ø18 mm, wall thickness 2 mm, powder coated

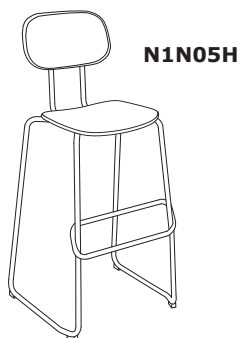

**N1N05H**

**Base N1N05H:**

- high stool
  - cantilever, metal
  - frame made of tube Ø18 mm, wall thickness 2 mm, powder coated
-

## Dimensions

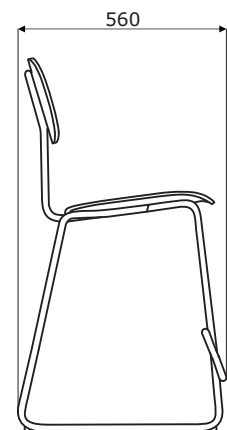
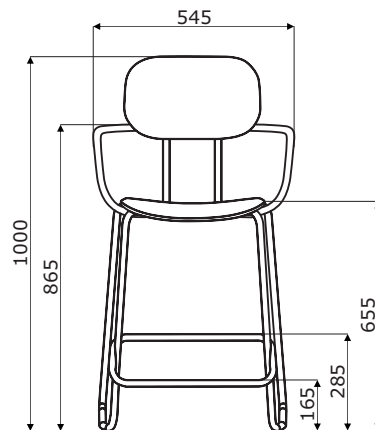
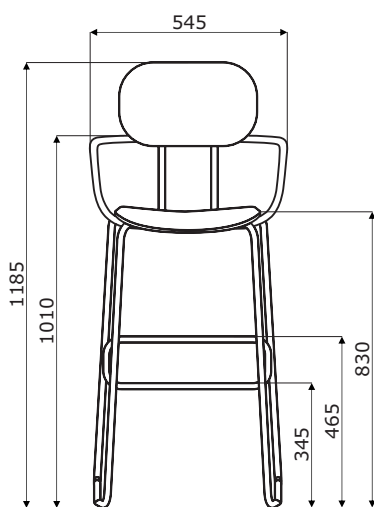
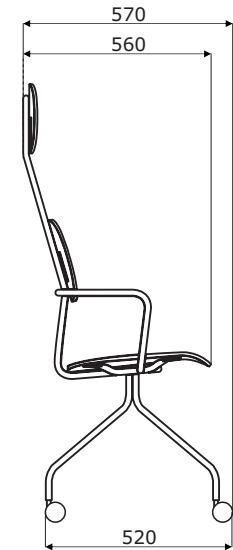
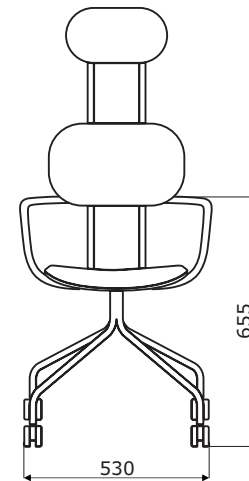
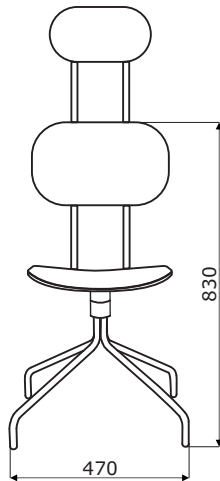
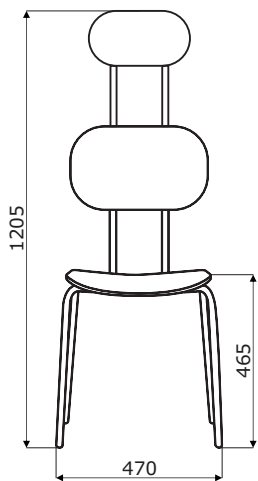
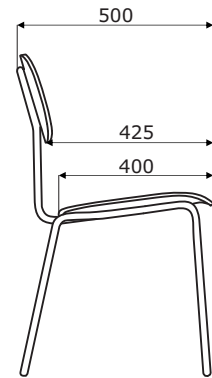
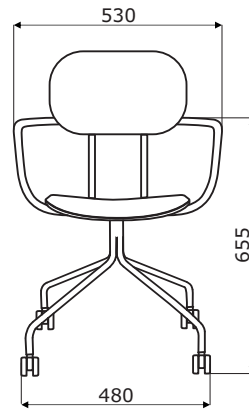
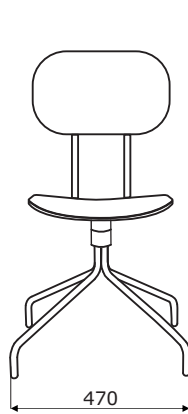
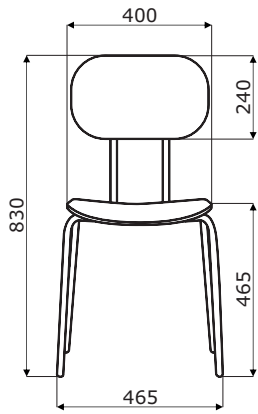

## New School



**N1N01 \***  
7 kg



**N1N07**  
7 kg



**N1N03K**  
7 kg



**N1N04H \***  
8 kg



**N1N05H \***  
9 kg



**N2N01**  
9 kg



**N2N07**  
9 kg



**N2N03K**  
9 kg

\* stacking - maximum of 5 pieces (only in the plywood finish chairs)

## Seat, back, headrest - plywood



M025 Light ash



M017 Light grey



M018 Dark grey



M019 Dark green



M020 Burgundy



M021 Red



M022 Black



## Base, armrest - metal



17 Chrom \*



M010 Light grey  
semi-matt RAL7044



17 Chrom \*



M011 Dark grey  
semi-matt RAL7042



17 Chrom \*



M012 Dark green  
semi-matt RAL6012



17 Chrom \*



M013 Burgundy  
semi-matt RAL3007



17 Chrom \*



M014 Red  
semi-matt RAL3016



17 Chrom \*



M115 Black  
semi-matt RAL9005



17 Chrom \*

## Castors



Black

\* OPTION WITH EXTRA CHARGE

**Upholstered seat – Fabric Note –  
third price group – back, headrest**



N-68156 Light green



N-61148 Grey



N-68155 Dark green

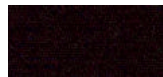

N-61125 Burgundy



N-63036 Rust-brown



N-60051 Graphite



**Base, armrest – metal**



M010 Light grey semi-matt RAL7044



17 Chrom \*



M011 Dark grey semi-matt RAL7042



17 Chrom \*



M012 Dark green semi-matt RAL6012



17 Chrom \*



M013 Burgundy semi-matt RAL3007



17 Chrom \*



M014 Red semi-matt RAL3016



17 Chrom \*



M115 Black semi-matt RAL9005



17 Chrom \*

**Technical data:**

<b>Material</b>	85% wools of New Zeland / 15% polyamide
<b>Fabric weight</b>	510g/m2 (16.45 OZ/lin.yd.)
<b>Abrasion resistance rubs</b>	200,000 Martindale cycles (EN ISO 12947-2)
<b>Colour fastness to light</b>	8 (EN ISO 105-B02)
<b>Colour fastness to rubbing</b>	dry: 4, wet: 4-5 (EN ISO 105x12)
<b>Flammability</b>	BS EN 1021 1&2(cigarette & match), BS 5852 0,1 cigarette & match, MED. Certifikat IMO, CA TB 117-2013

**Upholstered seat – Fabric Alcantara –  
fifth price group – back, headrest**

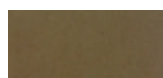

4180 Brown



6422 Anthracite



**Base, armrest**



17 Chrom \*



17 Chrom \*

**Technical data:**

<b>Material</b>	68% PES, 32% PU, 100 % PES
<b>Fabric weight</b>	350g/m2 (+/- 40g)
<b>Abrasion resistance rubs</b>	150,000 Martindale cycles (EN ISO 12947-2)
<b>Colour fastness to light</b>	5 (EN ISO 105-B02)
<b>Colour fastness to rubbing</b>	dry: 4, wet: 4 (EN ISO 105x12)
<b>Flammability</b>	BS5852 Crib 5 En1021 1+2 ÖN3800 B1/Q1 CH V.3

\* OPTION WITH EXTRA CHARGE

<b>New School</b>	Date of preparation 09.11.2020	The data contained in this document is valid in the day of its preparation. Change of the product, as long as it does not affect the basic features of it, does not require consistent updates of the document.	page 8/8
			colours